



camoflex[®]

BUS BODY BUILDING CHAMPION

WIPER SYSTEMS

DOOR SYSTEMS

WHEEL CHAIR RAMPS

WIRE HARNESS

FIRE SAFETY - FAPS & FDSS

 **YOUR ONE STOP SHOP** 



camoflex[®]
WIPER SYSTEMS

**FOR EVERY BUS COACH
CUSTOM BUILT WIPER SYSTEMS**

**OPPOSED / BUTTERFLY
WIPER SYSTEM KIT**

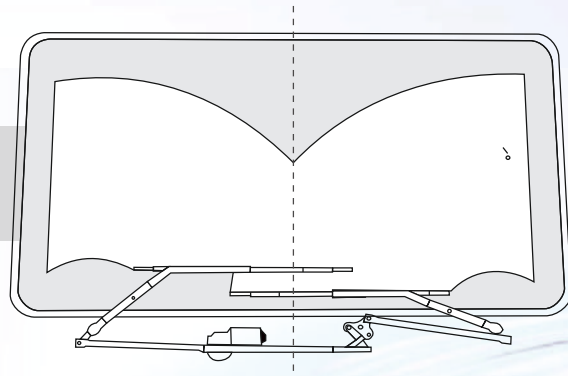

**RADIAL / TANDEM
WIPER SYSTEM KIT**

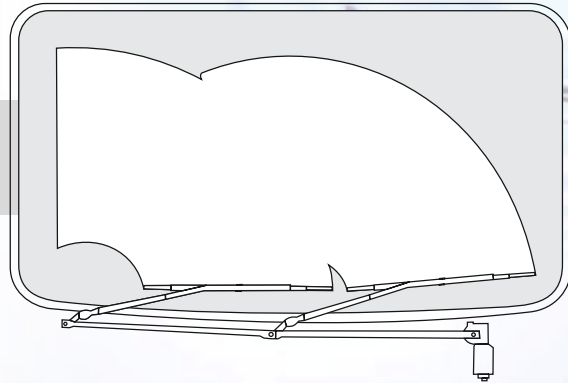

**PENTOGRAPH / HAND-CLAP
WIPER SYSTEM KIT**

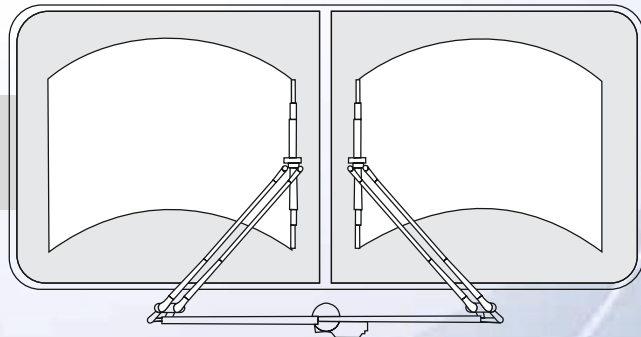

APPROVED BY

ARAI
Progress through Research

CIRT
Excellence in Transport



APPROVED AS ORIGINAL EQUIPMENT BY LEADING INDIAN & OVERSEAS VEHICLE MANUFACTURERS



camoflex[®]

WIPER MOTORS

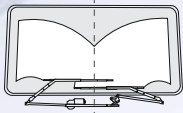

200w
180w

12V/24V



NOMINAL TORQUE	20 Nm	STALL TORQUE	170 Nm	DRIVE SHAFT	13.26 mm
----------------	-------	--------------	--------	-------------	----------

NOMINAL TORQUE	20 Nm	STALL TORQUE	130 Nm	DRIVE SHAFT	13.26 mm
----------------	-------	--------------	--------	-------------	----------

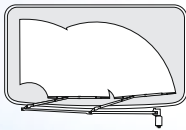

150w

12V/24V



NOMINAL TORQUE	20 Nm	STALL TORQUE	100 Nm	DRIVE SHAFT	13.26 mm
----------------	-------	--------------	--------	-------------	----------

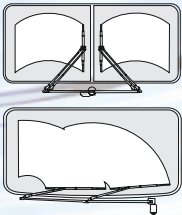

120w

12V/24V



NOMINAL TORQUE	20 Nm	STALL TORQUE	80 Nm	DRIVE SHAFT	13.26 mm
----------------	-------	--------------	-------	-------------	----------

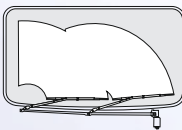

80w

12V/24V

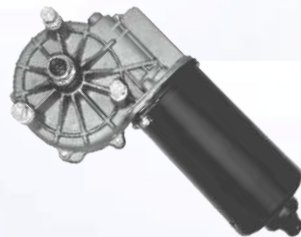

NOMINAL TORQUE	20 Nm	STALL TORQUE	60 Nm	DRIVE SHAFT	M8 TAPER
----------------	-------	--------------	-------	-------------	----------

NOMINAL TORQUE	20 Nm	STALL TORQUE	60 Nm	DRIVE SHAFT	9.2 mm
----------------	-------	--------------	-------	-------------	--------

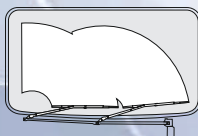

17w

12V/24V



NOMINAL TORQUE	5 Nm	STALL TORQUE	20 Nm	DRIVE SHAFT	M6 PIN
----------------	------	--------------	-------	-------------	--------

NOMINAL TORQUE	7 Nm	STALL TORQUE	24 Nm	DRIVE SHAFT	M8 PIN
----------------	------	--------------	-------	-------------	--------

APPROVED BY

ARAI
Progress through Research

CIRT
Excellence in Transport

ICAT
Innovation • Service • Excellence

APPROVED AS ORIGINAL EQUIPMENT BY LEADING INDIAN & OVERSEAS VEHICLE MANUFACTURERS





camoflex[®]
WIPER LINKAGES

OPPOSED / BUTTERFLY WIPER LINKAGE ASSY

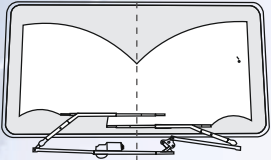

OPPOSED / BUTTERFLY WIPER LINKAGE ASSY (HEAVY DUTY)

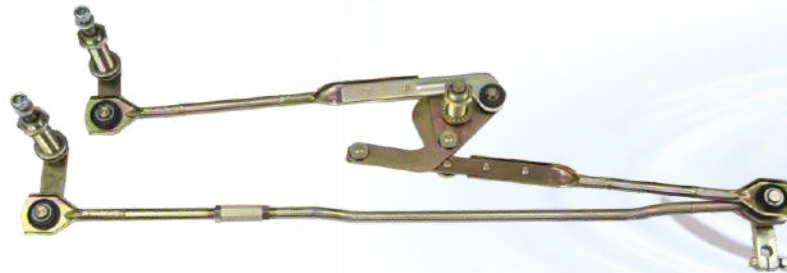
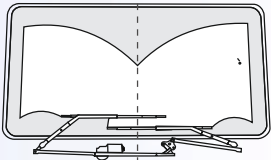

RADIAL / TANDEM WIPER LINKAGE ASSY

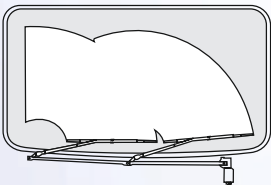

PENTOGRAPH / NAMASTE WIPER LINKAGE ASSY

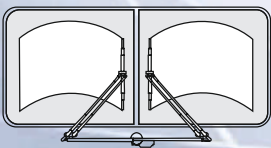

APPROVED AS ORIGINAL EQUIPMENT BY LEADING INDIAN & OVERSEAS VEHICLE MANUFACTURERS

AVAILABLE
OPTION



WIPER ARM TWIN PIPE

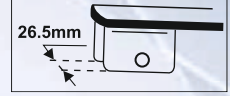

WIPER ARM
CLAMP INNER WIDTH

WIPER ARM SINGLE PIPE

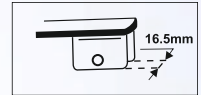

WIPER ARM
CLAMP INNER WIDTH

WIPER ARM PENTOGRAPH

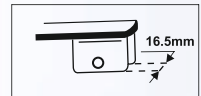

WIPER ARM
CLAMP INNER WIDTH

WIPER ARM THIN PATTI

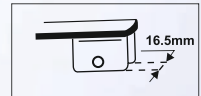

WIPER ARM
CLAMP INNER WIDTH

WIPER ARM BAYONET 9.5mm X 2.5mm



WIPER ARM ROD
WIDTH DIMENSION

HEAVY DUTY VOLVO TYPE WIPER BLADES

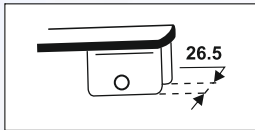

WIPER ARM CLIP FITMENT

Size - 32" to 40"

HEAVY DUTY M6 BOLT FIT WIPER BLADES

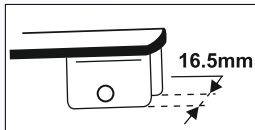

WIPER ARM CLIP FITMENT

Size - 20" to 32"

HEAVY DUTY BAYONET FIT WIPER BLADES

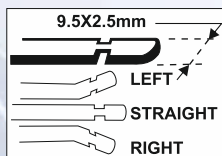

WIPER ARM CLIP FITMENT

Size - 17" to 26"

APPROVED BY



APPROVED AS ORIGINAL EQUIPMENT BY LEADING INDIAN & OVERSEAS VEHICLE MANUFACTURERS



**OPPOSED
WIPER
SYSTEMS**



camoflex®

LUXURY BUS WIPER KITS

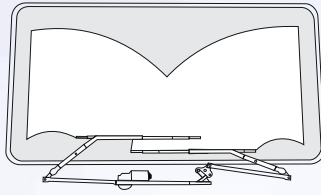

12v/24v
AVAILABLE



**WIPER ARM
CLAMP INNER
WIDTH**



AVAILABLE
OPTION

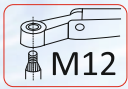
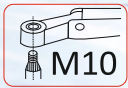

**WIPER ARM
CLAMP INNER
WIDTH**

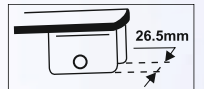

AVAILABLE
OPTION

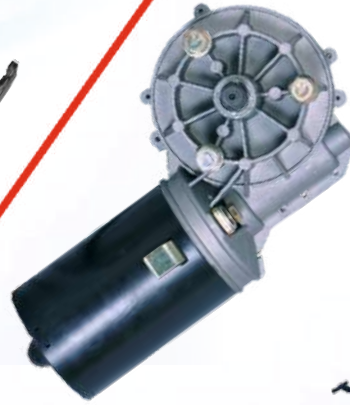
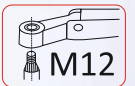
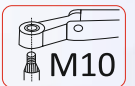

3L

12v/24v
AVAILABLE

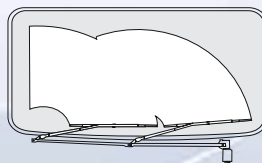

**RADIAL
WIPER
SYSTEM**



APPROVED AS ORIGINAL EQUIPMENT BY LEADING INDIAN & OVERSEAS VEHICLE MANUFACTURERS



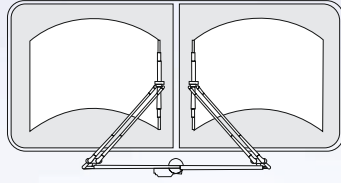

12v/24v
AVAILABLE



**WIPER ARM
CLAMP INNER
WIDTH**

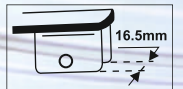

**AVAILABLE
OPTION**

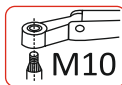
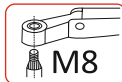

**WIPER ARM
CLAMP INNER
WIDTH**

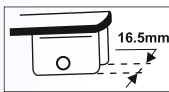

**AVAILABLE
OPTION**

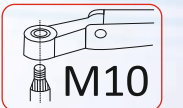

120W



80W



1L



700mm

12v/24v
AVAILABLE

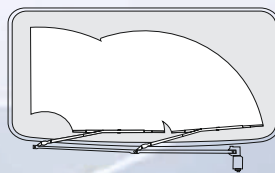

**RADIAL
WIPER
SYSTEM**





**3.5L WASHER TANK
WITH JET SPRAY PUMP**

12v/24v
AVAILABLE

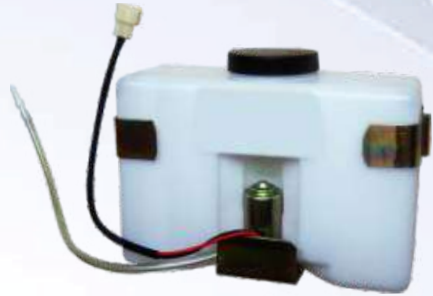

**3L WASHER TANK
WITH JET SPRAY PUMP**

12v/24v
AVAILABLE



**1.5L WASHER TANK
WITH JET SPRAY PUMP**

12v/24v
AVAILABLE



**1L WASHER TANK WITH
REAR BRACKET,
WITH JET SPRAY PUMP**

12v/24v
AVAILABLE



APPROVED BY



APPROVED AS ORIGINAL EQUIPMENT BY LEADING INDIAN & OVERSEAS VEHICLE MANUFACTURERS





camoflex[®]

AUTOMATIC BUS DOORS

JACK KNIFE DOORS

ELECTRO-PNEUMATIC
WITH PDV & I.R. SENSOR
MECHANISM & ELECTRICAL
MECHANISM WITH HUMAN
SENSOR

**AVAILABLE IN TOP MOUNTED
AND BOTTOM MOUNTED ASSY**



IN-SWING DOORS

ELECTRO-PNEUMATIC WITH
PDV & I.R. SENSOR
MECHANISM

**AVAILABLE IN TOP MOUNTED
AND BOTTOM MOUNTED ASSY**

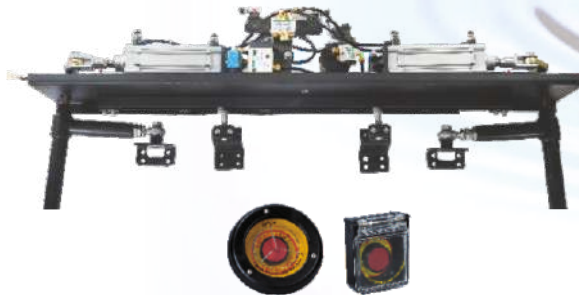

OUT-SWING DOORS

ELECTRO-PNEUMATIC
WITH PDV & I.R. SENSOR
MECHANISM

**AVAILABLE IN TOP MOUNTED
AND BOTTOM MOUNTED ASSY**



APPROVED BY



APPROVED AS ORIGINAL EQUIPMENT BY LEADING INDIAN & OVERSEAS VEHICLE MANUFACTURERS

PLUG DOOR MECHANISM

ELECTRO-PNEUMATIC WITH PDV &
I.R. SENSOR MECHANISM



JK DOOR ELECTRICAL MECHANISM

ELECTRICAL MECHANISM WITH HUMAN SENSOR

This mechanism has a micro-controlled SMD. They also include features such as human safety & emergency switch Inside & Outside for Safety purpose. This is suitable only for 12v buses without an AIR Compressor module.



APPROVED BY



APPROVED AS ORIGINAL EQUIPMENT BY LEADING INDIAN & OVERSEAS VEHICLE MANUFACTURERS





IC ENGINE BUS HARNESS

BUS HARNESS FOR ENGINE TRANSMISSION

BUS HARNESS FOR PASSENGER CABIN

BUS HARNESS FOR HVAC

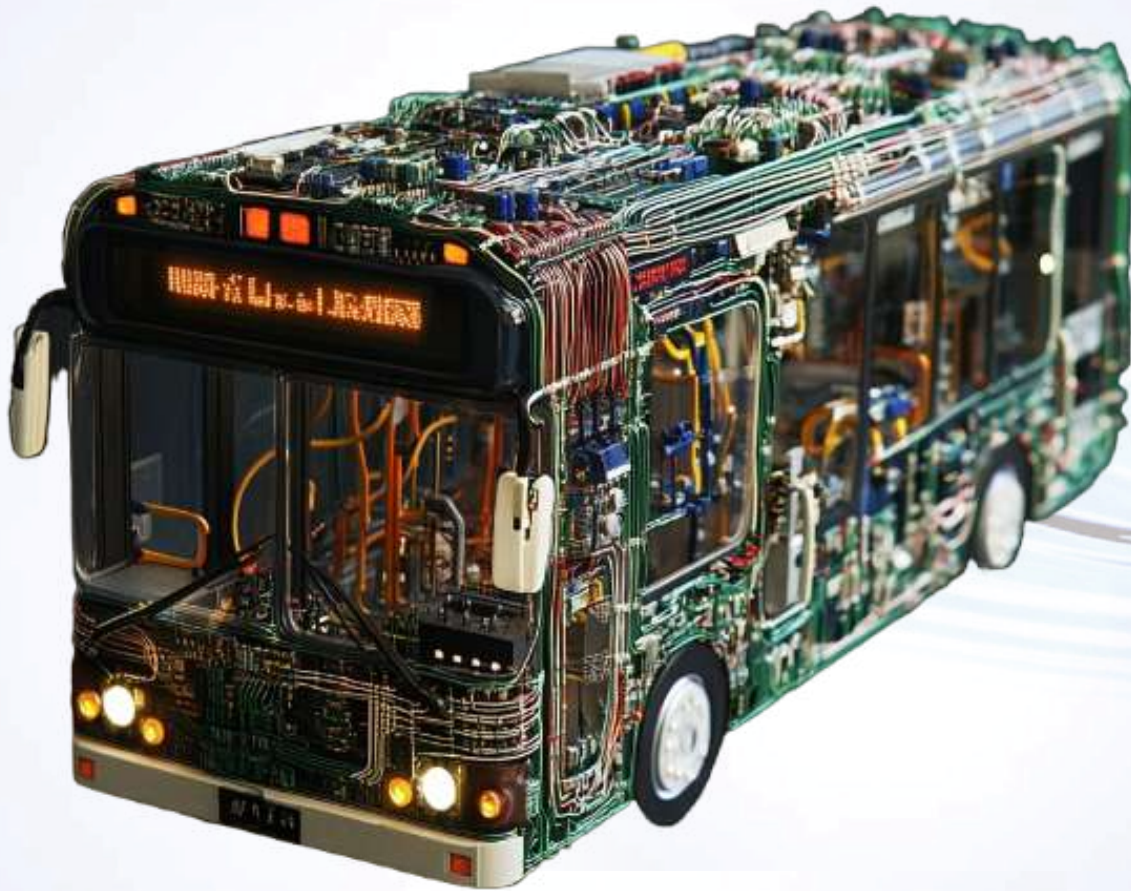

EV BUS HARNESS

EV BUS HARNESS FOR L.V. & H.V. COMPLETE

EV BUS BATTERY CABLES IN F.R. GRADE

**WIRE HARNESS SPECIALLY CUSTOM BUILT
TO GIVE YOU SAFETY & PERFORMANCE**

APPROVED BY



APPROVED AS ORIGINAL EQUIPMENT BY LEADING INDIAN & OVERSEAS VEHICLE MANUFACTURERS

**ASSEMBLY BOARD
MOTORISED**



**ASSEMBLY
PROCESS**



**ULTRASONIC
WELDING MACHINE**

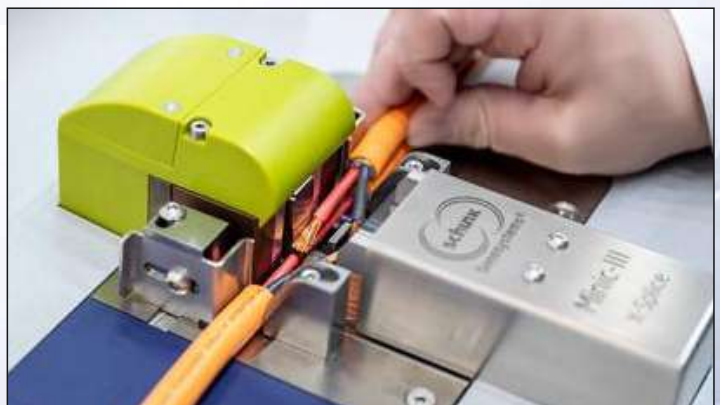

APPROVED BY



APPROVED AS ORIGINAL EQUIPMENT BY LEADING INDIAN & OVERSEAS VEHICLE MANUFACTURERS





TRANSMISSION HARNESS WITH FUSE BOX

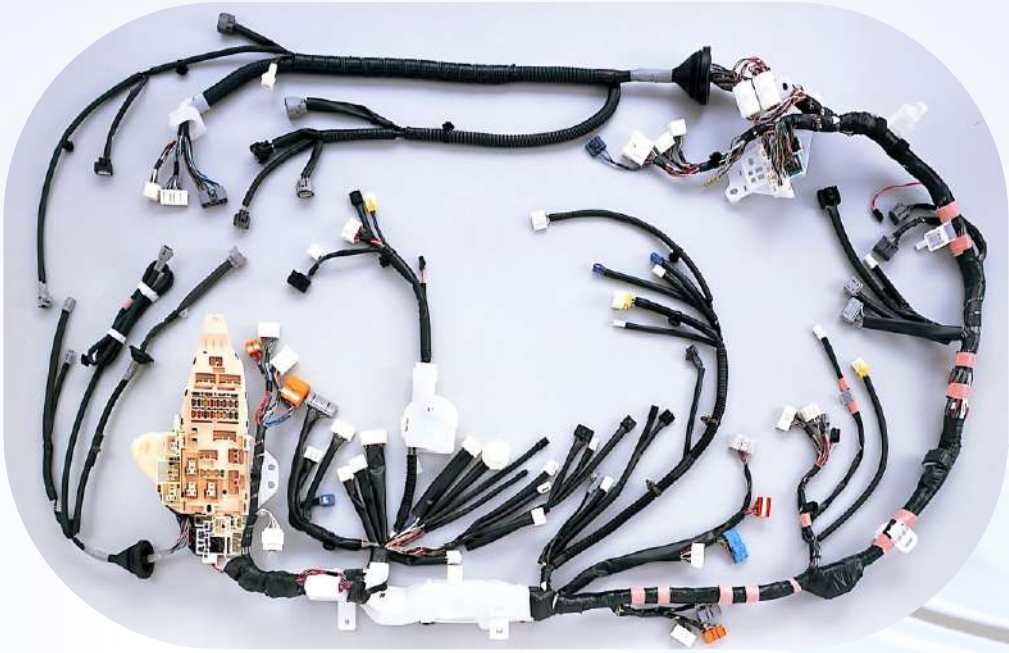

COMPLETE ELECTRICAL SOLUTION



APPROVED BY



APPROVED AS ORIGINAL EQUIPMENT BY LEADING INDIAN & OVERSEAS VEHICLE MANUFACTURERS

WHEEL CHAIR RAMPS



camoflex[®]
MOBILITY

FLIP TYPE MANUAL WHEEL CHAIR RAMP

**WHEEL CHAIR RAMP
FOR 400mm
FLOOR HEIGHT**



FLIP TYPE ELECTRICAL WHEEL CHAIR RAMP

**WHEEL CHAIR RAMP
FOR 400mm FLOOR HEIGHT**

12v/24v

AVAILABLE



CASSETTE TYPE ELECTRICAL JUMP-STOP WHEEL CHAIR RAMP

**WHEEL CHAIR RAMP
FOR 400-600mm FLOOR HEIGHT**

12v/24v

AVAILABLE



APPROVED BY



APPROVED AS ORIGINAL EQUIPMENT BY LEADING INDIAN & OVERSEAS VEHICLE MANUFACTURERS



FIRE ALARM & PROTECTION SYSTEM (FAPS)

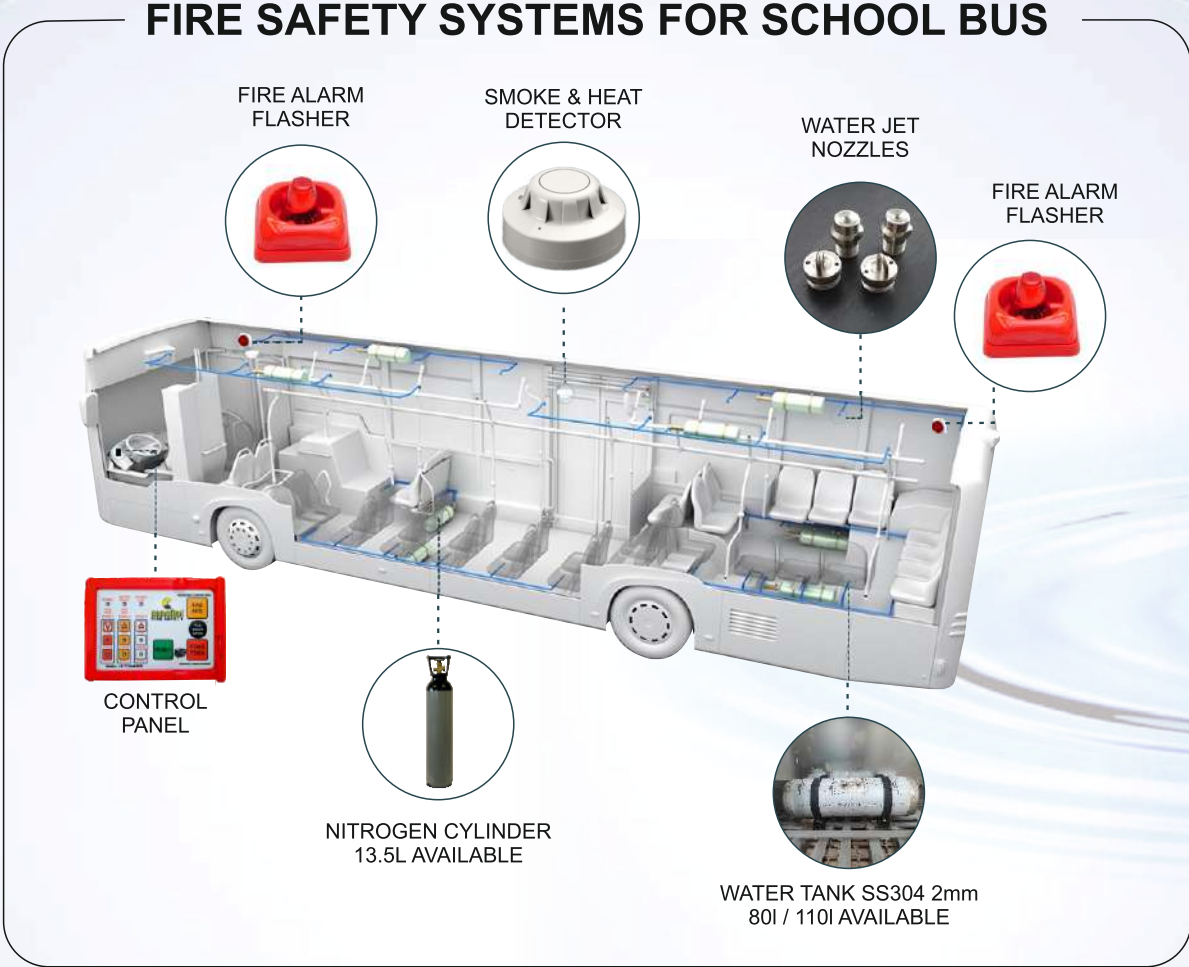

COMPLETE KIT



CERTIFIED BY:



APPROVED AS ORIGINAL EQUIPMENT BY LEADING INDIAN & OVERSEAS VEHICLE MANUFACTURERS

FIRE DETECTION & SUPPRESSION SYSTEM (FDSS)

LHS CABLE



CONTROL PANEL



HOOTER



CYLINDER WITH VALVE

ENGINE SUPPRESSION GRID

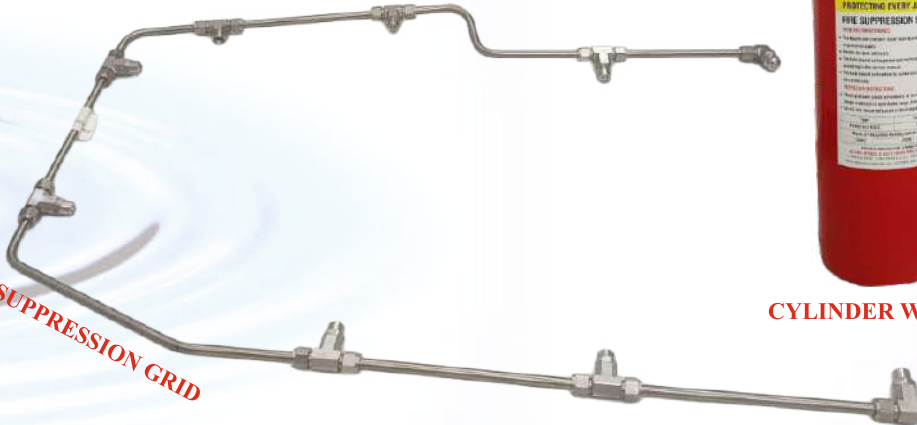

WORKING :-

- LINEAR HEAT SENSOR DETECTS FIRE IN BUS ENGINE AREA.
- SYSTEM ACTIVATES AUTOMATICALLY & MANUALLY UPON DETECTION.
- PRESSURIZED ABC POWDER SPRAYS ON TO ENGINE CABIN THROUGH STEEL TUBES & NOZZLES.



CERTIFIED BY:



APPROVED AS ORIGINAL EQUIPMENT BY LEADING INDIAN & OVERSEAS VEHICLE MANUFACTURERS





camoflex[®] CERTIFICATES



दि ऑटोमोटिव रिसर्च एसोसिएशन ऑफ इंडिया
The Automotive Research Association of India
(Research Institute of the Automotive Industry with the Ministry of Heavy Industries, Govt. of India)



DISCIPLINE: MECHANICAL		GROUP: AUTOMOTIVE COMPONENT	ULR No. TC508524010000363F
TEST REPORT			
No. SHL/16/2023-2024/3000034955/TA/0733		DATE: 27.02.2024	
1.0 NAME AND ADDRESS OF THE CUSTOMER	Allied Spares and Auto Parts Mfg. Co. Pvt Ltd, 16, 1 st Bhatwadi Girum, Mumbai - 400004		
Name of Contact Person	GS Mago		
Telephone No.	7738570000		
Email ID	Gc@camoflexindia.com		
2.0 CUSTOMER LETTER REF.	E-mail Dated: 31.01.2024		
2.1 CSP Receipt Date	05.02.2024		
DESCRIPTION OF TEST COMPONENTS:			
a. Name of The Component	Wiper Blades		
b. Name and Address of the Manufacturer	Allied Spares and Auto Parts Mfg. Co. Pvt Ltd, Plot # 1709, Phase III, G. I.D.C., Vapi-396 195		
c. Part No.	Refer Annexure-I		
d. Material	Natural & Chloroprene Blended Grade-WRC 60		
e. Length of wiper blade	Refer Annexure-I		
f. Drawing No.	00255522200, Rev No. 00 for 10mm 001777XX100, Rev No. 00 for 6mm		
TEST OBJECTIVE			
To conduct Wiper blade test as per CI No 4 2.5 of IS 15804:2008 and CI No 5.2 of AIS 011			
TEST REQUIREMENTS & TEST RESULT			
Sr. No.	Test	Test Requirement	Observation
1.	Ozone Testing	Specimens shall be examined for signs for cracks and shall not show cracks under '7X' magnification after Following Conditions Test specimens after preparation shall be placed in Ozone test chamber for a period of 72 hours. The test chamber is to be operated at a temperature of 40±3°C And at a concentration of 50 ppm, by volume.	No Cracks observed on the samples.

PREPARED BY:	VERIFIED BY:	AUTHORISED BY:
S. N. LONDHE DEPUTY MANAGER	A. D. DEKATE GENERAL MANAGER	DR. B. V. SHAMSUNDARA DEPUTY DIRECTOR In-charge-Safety and Homologation Laboratory

Page 1 of 2-Annexure-I (1 Page) & Drawing (2 Page)

संकेतिक संदर्भ : सी - 402, वेदांग हिल, ऑफ प्लांट रोड, कोठरुड, पुणे - 411038. डाटा सा : ऑफिस सी. 42, पुणे - 411004 (महाराष्ट्र)
Regd. Office: S. No. 102, Veda Hill, Off Plant Road, Kothrud, Pune-411038 (India) P.B. No. 832, Pune-411004 (India)
Tel.: +91-20-6762-1101/1111, Fax: +91-20-6762-1104, Email: director@araiindia.com Website: www.araiindia.com



The Automotive Research Association of India
(Research Institute of the Automotive Industry with the Ministry of Heavy Industries & Public Enterprises, Govt. of India)



TEST REPORT

ARAI/AED/20212022/3000021566/CT/1862 Dated:08-MAR-2022 CONFIDENTIAL
ULR No. TC50852200000159F Discipline: Electronics Group: EMC

1.0 Name and address of the customer	ALLIED SPARES & AUTO PARTS MANUFACTURING COMPANY PRIVATE LIMITED, PLOT NO 1709, CAMOFLEX HOUSE III PHASE, VAPI, VALSAD, VALSAD-396195 Gujarat, Email Dated: 26-FEB-2022		
2.0 Customer letter reference			
3.0 Description of the Device Under Test (DUT)	DUT Name	Wiper motor	
	Manufacturer Name	ALLIED SPARES & AUTO PARTS MANUFACTURING COMPANY PRIVATE LIMITED.	
	Model Name	180 W	
	Part No.	180 W	
4.0 Test objective	To carry out EMI/EMC tests as per details given in table 8.0		
5.0 Condition of the test component	The test component was received in good condition.		

V S PANGE ENGINEER	A A PAPADE Dy GENERAL MANAGER	A A DESHPANDE Sr.Dy. DIRECTOR & HoD

Page 1 of 4

AN ISO 9001:2015, ISO 14001:2015, ISO 45001 and ISO/IEC 17025 Certified and ISO/IEC 17025 Accredited Organization

Regd. Office: S. No. 102, Veda Hill, Off Plant Road, Kothrud, Pune-411038 (India) P.B. No. 832, Pune-411004 (India)
Tel.: +91-20-6762-1101, 1111 Fax: +91-20-6762-1104, 1104 Email: director@araiindia.com, Website: www.araiindia.com
ARAI Regional Centre South (ARAI/RC/S), Chennai



दि ऑटोमोटिव रिसर्च एसोसिएशन ऑफ इंडिया
The Automotive Research Association of India
(Research Institute of the Automotive Industry with the Ministry of Heavy Industries, Govt. of India)



TEST REPORT

ARAI/AED/20242025/3000042635/CT/2484 Date of Issue: 14-Feb-2025 CONFIDENTIAL
ULR No. TC60852600000217F Discipline: Electronics Group: EMC

1.0 Name and address of the customer	ALLIED SPARES & AUTO PARTS MANUFACTURING COMPANY PRIVATE LIMITED, PLOT NO 1709, CAMOFLEX HOUSE III PHASE, VAPI, VALSAD, VALSAD-396195, GUJARAT		
2.0 Customer letter reference	E-mail, Dated: 03.02.2025		
3.0 Test facility details	The Automotive Research Association of India (ARAI) S. No 102, Veda Hill, off Paud Road, Kothrud, Pune - 411038, Maharashtra, India.		
4.0 Description of the Device Under Test (DUT)	DUT Name	Fire Detection Alarm & Suppression Control Panel	
	Model Name	FAPS-FDSS-FAS	
	Model Number	FAPS-FDSS-FAS-001	
	Manufacturer Name	ALLIED SPARES & AUTO PARTS MFG CO PVT LTD	
5.0 Test objective	To carry out EMI/EMC tests as per AIS-004 (Part 3), as amended from time to time. Tests details given in table 9.0		
6.0 Condition of the test component	The test component was received in good condition.		

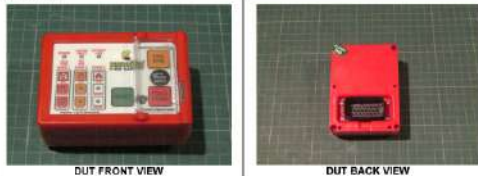

			Digitally signed by AAKTYA AJIT PAPADE Date: 2025.02.14 19:30:00+05:30
V S PANGE Dy. MANAGER	A S MADALGI MANAGER	A A PAPADE Dy. GENERAL MANAGER	Approved By

Page 1 of 5

संकेतिक संदर्भ : सी - 402, वेदांग हिल, ऑफ प्लांट रोड, कोठरुड, पुणे - 411038. डाटा सा : ऑफिस सी. 42, पुणे - 411004 (महाराष्ट्र)
Regd. Office: S. No. 102, Veda Hill, Off Plant Road, Kothrud, Pune-411038 (India) P.B. No. 832, Pune-411004 (India)
Tel.: +91-20-6762-1101/1111, Fax: +91-20-6762-1104, Email: director@araiindia.com Website: www.araiindia.com



The Automotive Research Association of India
(Research Institute of the Automotive Industry with the Ministry of Heavy Industries, Govt. of India)



TEST REPORT

ARAI/AED/20232024/3000025201/CT/0140 Dated:27-APR-2023 CONFIDENTIAL
ULR No TC50852300000432F Discipline: Electronics Group: EMC

1.0 Name and address of the customer	ALLIED SPARES & AUTO PARTS MANUFACTURING COMPANY PRIVATE LIMITED, PLOT NO 1709, CAMOFLEX HOUSE III PHASE, VAPI, VALSAD-396195, Gujarat.		
2.0 Customer letter reference	E mail Dated: 30-MAR-2023		
3.0 Description of the Device Under Test (DUT)	DUT Name	DC-DC ELECTRO PNEUMATIC MECHANISM & ASSY.	WITH DOOR
	Model Name	DC-DC ELECTRO PNEUMATIC MECHANISM & ASSY.	WITH DOOR
	Manufacturer Name and Address	ALLIED SPARES & AUTO PARTS MANUFACTURING COMPANY PRIVATE LIMITED, CAMOFLEX HOUSE, #1709A, VAPI-396195, Gujarat	
	Model Number	V570V24V12	
4.0 Test objective	To carry out EMI/EMC tests as per details given in table 8.0		
5.0 Condition of the test component	The test component was received in good condition.		

V S PANGE ENGINEER	A A PAPADE Dy. GENERAL MANAGER	M M DESAI Dy. DIRECTOR

Page 1 of 5

AN ISO 9001:2015, ISO 14001:2015, ISO 45001 and ISO/IEC 17025 Certified Organization
Regd. Office: S. No. 102, Veda Hill, Off Plant Road, Kothrud, Pune-411038 (India) P.B. No. 832, Pune-411004 (India)
Tel.: +91-20-6762-1101, 1111 Fax: +91-20-6762-1104, 1104 Email: director@araiindia.com, Website: www.araiindia.com
ARAI Regional Centre South (ARAI/RC/S), Chennai



APPROVED AS ORIGINAL EQUIPMENT BY LEADING INDIAN & OVERSEAS VEHICLE MANUFACTURERS

CALCULATION FOR NOZZLES & WATER TANK

Sr. No.	Seating Capacity	Gross Volume Range (M)	No of Nozzles (Minimum)	Water Qty. (L)
1	20	LESS THAN 20	9	55
2	30	20 TO 30	13	80
3	40	30 TO 40	18	110
4	50	40 TO 50	22	130
5	60	50 TO 60	26	155
6	70	60 TO 70	30	185
7	80	70 TO 80	35	210

ADVANTAGES OF FAPS

- MULTI-SENSOR DETECTS SMOKE OR HEAT IN BUS PASSENGER COMPARTMENT.
- ALARM SYSTEM ACTIVATES AUTOMATICALLY UPON DETECTION.
- AFTER CHECKING SIGNAL VISUALLY, IF FIRE PRESENT IN PASSENGER COMPARTMENT, PRESS THE FAS/FPS BUTTON TO ACTIVATE THE WATER MIST SYSTEM.
- PRESSURIZED WATER MIST SPRAYS INTO CABIN THROUGH STEEL PIPES & DRDO APPROVED NOZZLES.
- WATER MIST SPRAY AND NITROGEN PROVIDES COLD WATER SHOWER.

APPROVED BY



AIS 135 APPROVED

APPROVED AS ORIGINAL EQUIPMENT BY LEADING INDIAN & OVERSEAS VEHICLE MANUFACTURERS





camoflex[®]

BUS BODY BUILDING CHAMPION

Manufactured by:

ALLIED SPARES & AUTO PARTS MFG. CO. PVT. LTD.

'Camoflex House', 1709A, Phase 3, G.I.D.C.,

Vapi - 396 195, Gujrat, India.

Customer Care : +91 7738 44 0000

Email: enquiry@camoflexindia.com

URL: www.camoflexindia.com